

Rolux Condensation Gaz et Fioul Rénolux 60/100-60 | 80/125-80 | 100/150-110

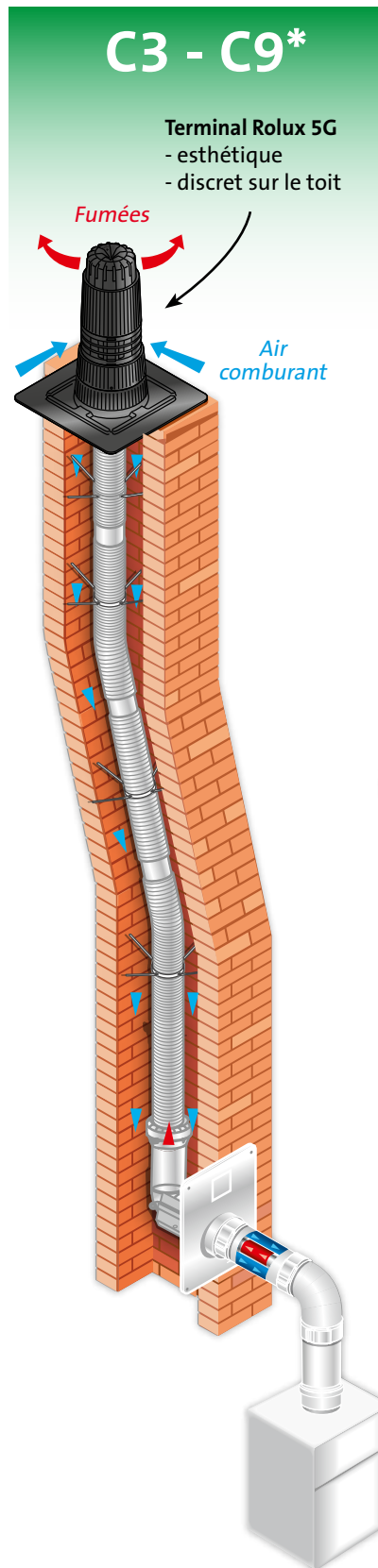

> Principe général



Reprenant le principe des conduits concentriques, la configuration Rénolux permet la réhabilitation d'un conduit existant pour l'implantation d'un appareil étanche.

Les gaz brûlés sont évacués via le conduit concentrique, de la chaudière jusqu'au boisseau. Puis du boisseau jusqu'au terminal. L'air frais, pris au terminal, est acheminé à la chaudière par le boisseau et le conduit concentrique.

Cette configuration est identique au principe du système concentrique et permet les mêmes longueurs de raccordement fournies par le fabricant de l'appareil. Ce système sécurisant ne nécessite pas la ventilation du local chaudière.

Caractéristiques

Conduits gaz brûlés : PPTL

Conduits air comburant : PVC

Conduits et terminal recoupables excepté le conduit coulissant et les coudes

Joint montés en usine

DTA Référence Avis Technique 14/12 - 1728

Marquage CE de la chaudière

C3 = vertical

C9 = vertical

Pourquoi un kit ?

Un kit type répond au besoin de votre installation dans le respect de la réglementation. Nos kits sont disponibles en noir et ocre.

NOUVEAU

**KIT 2EN1
80/125 - 80**



**SYSTÈME
SÉKURIT
(Ø80/125)**

- Utilisation simplifiée
- Performances optimisées

> Le coude, pièce clé !

ENTRÉE MURALE

ENTRÉE PLAFOND

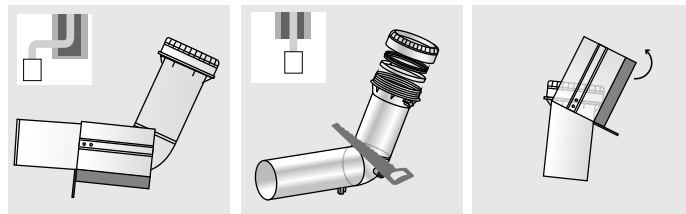

COUPEZ LE COUDE...

ET OBTENEZ UNE ENTRÉE PLAFOND !



YouTube
**VISIONNEZ
LES VIDÉOS
DE POSE
DU KIT 2EN1**



Scannez ce QR
code et accédez
à notre fiche
produit en ligne

* C32-C33/C92-C93

➤ Produits

Ø 60/100-60

Les kits



ENTRÉE MURALE



ENTRÉE PLAFOND



Terminal



Adaptateur pour flexible



Solin recoupable



Bride de blocage



Longueur droite 500 mm



Bride de fixation



Ensemble support de coude



Plaque de finition



Longueur droite 250 mm



Plaque de finition

Ø 80/125-80



ENTRÉE MURALE & PLAFOND

KIT 2EN1 NOUVEAU



Terminal



Adaptateur pour flexible



Solin recoupable



Coude



Support de coude



Plaque de finition

ACCESSOIRE



Flexible*

Ø 100/150-110



ENTRÉE MURALE



Anti-volatiles



Adaptateur pour flexible



Bague de fixation pour flexible



Couvre-cheminée



Bride de blocage



Adaptateur



Conduit PPTL 310 mm



Coude PPTL



Collier de fixation



Règle de fixation



2 crémaillères de réglage



2 barres supports de coude



Plaque de finition



Conduit PPTL longueur 500 mm

* Pour Ø 60/100-60 et 80/125-80 disponible en 25 et 50 mètres. Pour Ø 100/150-110 disponible en 15 et 25 mètres

Les conduits et coudes (avec système Sékurit*)



Conduit
1 m, 0,5 m, 0,25 m



Coude 87°



Coude 45°
(vendu par 2)



Conduit coulissant



Coude 87°
de visite



Longueur droite
1 m, 0,5 m, 0,25 m



Coude 87°



Coude 45°
(vendu par 2)

Les accessoires



Raccord flexible à flexible



Araignée de centrage
(vendue par 6)



Kit large mitron
(noir ou ocre)



Raccord flexible à flexible



Kit adaptateur



Araignée de centrage
(vendue par 6)



Kit large mitron
(noir ou ocre)



Raccord flexible à flexible



Kit adaptateur



Araignée de centrage
(vendue par 6)